



Specification sheet

Fire pump drive engine

CFP9E-F50 CFP9EVS-F50



Description

Engine series - Cummins QSL9 Series
Exhaust emissions - EPA Tier 3

With advanced electronics, higher torque, and better speed control, the CFP9E allows for shorter service times, longer maintenance intervals, increased fuel economy, and up to 50% less noise. This midrange engine with the Variable Speed Pressure Limiting Control (VSPLC) option provides an additional array of horsepower options than the CFP5E or CFP7E models.

Features

Variable Speed Pressure Limiting Control (VSPLC) - Cummins' VSPLC-equipped fire pump drive engines are capable of maintaining a constant pump discharge pressure by controlling the engine speed down to 1200 RPM, while still maintaining T3 emissions certification. VSPLC fire pump drive engines provide design flexibility in the fire pump system for high-rise applications; compensate for varying discharge pressure; allow the system architect to apply a larger pump and/or a pump with a steeper curve; and significantly reduce water consumption during the weekly test.

Certified power - The CFP9E-F50 complies with NFPA 20 and is UL 1247 Listed and FM 1333 Approved. The CFP9EVS-F50 complies with NFPA 20 and is FM 1333 Approved.

Control system - The industry-leading, state-of-the-art Fire Pump Digital Panel (FPDP) provides total fire pump drive engine system integration and intuitive operation, including:

- Color touchscreen;
- Dual microprocessors for critical signal redundancy;
- Standard J1939 parameter and Cummins fault code display;
- Engine idling;
- Electronic Control Module (ECM) self-diagnosis; and
- Optional Modbus field server remote messaging capability.

Warranty and service - Our models are backed by a comprehensive warranty and worldwide distributor network.

Ratings in HP (kW) and certifications

Operating speed (RPM)	1470		1760		1900		2100		2300	
	HP	(kW)	HP	(kW)	HP	(kW)	HP	(kW)	HP	(kW)
CFP9E-F50 NFPA, UL & FM	291	(217)	350	(261)	363	(271)	335	(250)	304	(227)
CFP9EVS-F50 NFPA & FM	291	(217)	350	(261)	363	(271)	335	(250)	304	(227)

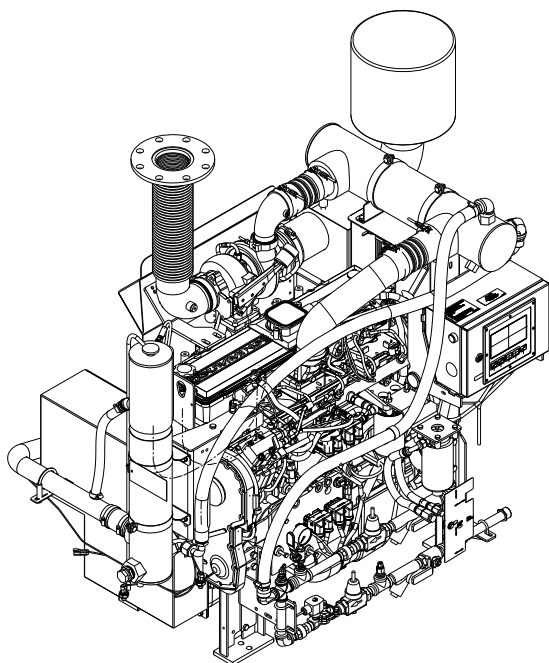

General engine data

Engine type	4 Cycle; In-Line, 6 Cylinder
Aspiration	Turbocharged and Charge-Air Cooled
Bore and stroke	4.49 x 5.69 in. (114 x 145 mm)
Displacement	543 in ³ (8.9 L)
Rotation	Counterclockwise from flywheel end
Compression ratio	17.8:1
Valves per cylinder	Intake - 2 Exhaust - 2
Fuel system	Cummins Common Rail (CCR)
Maximum allowable bending moment @ rear face of block	1000 lb.-ft. (1356 N-m)
Estimated wet weight*	3470 lbs. (1574 kg)

* Weight includes engine, cooling loop, heat exchanger, dual Electronic Control Modules (ECMs), Fire Pump Digital Panel (FPDP), standard air cleaner, standard exhaust flex, and all fluids.

Equipment	Standard	Optional
Air cleaner	Disposable; treated for high humidity, indoor service	Heavy-duty, two-stage with replaceable elements
Alternator	12V-DC, 95 amps; includes belt guard	24V-DC, 45 amps with belt guard
Cooling loop (maximum pressure of 300 PSI)	3/4" diameter for fresh water; includes alarm sensors and FM-approval	Cu Ni construction available for sea water applications; approved loops up to 1 1/4"
Cooling system	Tube and shell type, 60 PSI with NPTF connections	Radiator ¹ ; sea water tube and shell
Engine heater	120V-AC, 2250 watts	240V-AC, 2250 watts
Exhaust protection	Metal guards on manifolds and turbocharger	N/A
Exhaust flex connection	Steel, flanged	Stainless steel flex, NPT
Flywheel power take-off	Flywheel	Driveshaft system, stub shaft
Fuel connections	Fire-resistant flexible supply and return lines	N/A
Fuel filter	Primary and secondary	N/A
Governor, speed	Constant speed, adjustable	VSPLC ²
Fire pump digital panel (FPDP)	7" color touchscreen; enclosure rated as Type 2/Type 4X; Imperial and metric values	Optional 316SS construction; custom gauges with digital panel expansion module (DPEM)
Lube oil cooler	Engine-water-cooled, plate type	N/A
Lube oil filter	Full-flow with by-pass valve	N/A
Lube oil pump	Gear-driven	N/A
Manual start controls	On FPDP and/or contactors	N/A
Overspeed controls	Electronic with reset and test on FPDP	N/A
Starter	12V-DC	24V-DC/pneumatic ³ /hydraulic ³

¹ Not UL Listed and not FM Approved.

² FM Approved, but not UL Listed.

³ Only approved as a secondary starter

Air induction system

Maximum temperature rise between ambient air and engine air inlet	30 °F (16.7 °C)
Maximum inlet restriction with dirty filter	25 in. H ₂ O (635 mm H ₂ O)
Recommended air cleaner element - (standard)	Cummins Filtration AH19220
Recommended air cleaner element - (heavy duty)	Optional: primary element AF1828; secondary element AF1894M

Lubrication system

Oil pressure range at rated	40-60 PSI (276-414 kPa)
Oil capacity of pan (high - low)	24-20 qt. (23-19 L)
Total system capacity	6.5 gal. (24.6 L)
Recommended lube oil filter	Cummins Filtration LF9009

Cooling system*

Raw water working pressure range at heat exchanger	60 PSI (413 kPa) MAX
Recommended minimum water supply pipe size to heat exchanger	.75 in. (19.05 mm)
Recommended minimum water discharge pipe size from heat exchanger	1.00 in. (25.40 mm)
Coolant water capacity (engine only)	2.9 gal. (11 L)
Standard thermostat - type	Modulating
Standard thermostat - range	180-199 °F (82-93 °C)
Normal Operating Temperature	180-212 °F (82-100 °C)
Minimum raw water flow:	
- with water temperatures to 60 °F (16 °C)	28.5 GPM (1.8 L/sec)
- with water temperatures to 80 °F (27 °C)	30.3 GPM (1.91 L/sec)
- with water temperatures to 100 °F (38 °C)	32 GPM (2.02 L/sec)
Recommended cooling water filter	Cummins Filtration WF2074

* A jacket water heater is mandatory on this engine. The recommended heater wattage is 2250 down to 40 °F (4 °C)

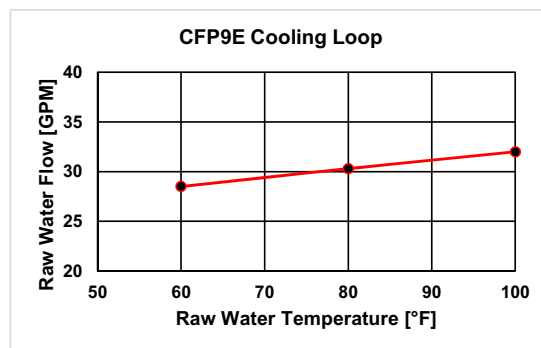

Exhaust system

Maximum allowable back pressure by complete exhaust system	40.8 in. H ₂ O (10.2 kPa)
Exhaust pipe size normally acceptable	5 in. (127 mm)

Noise emissions - The noise emission values are estimated sound pressure levels at 3.3 ft. (1 m).

Top	97.2 dBa
Right side	97.2 dBa
Left side	97.2 dBa
Front	97.2 dBa
Exhaust	119.5 dBa

Fuel supply/drain system

Operating speed in RPM	1470		1760		1900		2100		2300	
Fuel rate - gal/hr (L/hr)	14.9	(56.5)	18.1	(68.5)	18.7	(70.6)	17.4	(65.8)	15.3	(57.7)
Fuel type	No. 2 diesel only									
Minimum supply line size	0.5 in. (12.70 mm)									
Minimum drain line size	0.375 in. (9.53 mm)									
Maximum fuel height above C/L fuel pump	227 in. (5.7 m)									
Recommended fuel filter - primary	Cummins Filtration FF5580									
Recommended fuel filter - secondary	Cummins Filtration FS1212									
Maximum restriction @ lift pump-inlet - with clean filter	4.0 in. Hg (102 mm Hg)									
Maximum return line restriction - without check valves	10.0 in. Hg (254 mm Hg)									
Minimum fuel tank vent capability	7.1 ft ³ /hr (0.21 m ³ /hr)									
Maximum fuel temperature @ lift pump inlet	160 °F (71 °C)									

Starting and electrical system

Minimum recommended battery capacity - cold soak at 0 °F (-18 °C) or above	12V	24V
Engine only - cold cranking amperes	1400 CCA*	900 CCA*
Engine only - reserve capacity	430 minutes*	430 minutes*
*Based on FM requirement for a minimum of 900 CCA and 430 reserve capacity minutes		
Battery cable size - minimum of 2/0 AWG and maximum cable length not to exceed 6 ft. (1.5 m)	12V	24V
Maximum resistance of starting circuit	0.002 Ohms	0.002 Ohms
Typical cranking speed	130 RPM	130 RPM
Alternator (standard), internally regulated	95 amps	45 amps

Operating conditions

Operating speed in RPM	1470		1760		1900		2100		2300	
Output - BHP (kW)	291	(217)	350	(261)	363	(271)	335	(250)	304	(227)
Ventilation air required - CFM (litre/sec)	584	(276)	686	(324)	736	(347)	785	(371)	824.3	(389)
Exhaust gas flow - CFM (litre/sec)	1621	(765)	1918	(905)	2053	(969)	2107	(995)	2065	(975)
Exhaust gas temperature - °F (°C)	1097	(592)	1097	(592)	1097	(592)	1097	(592)	1097	(592)
Heat rejection to coolant - BTU/min. (kW)	4849	(85)	6157	(108)	6815	(120)	6530	(115)	6008	(106)
Heat rejection to ambient - BTU/min. (kW)	1186	(21)	1263	(22)	1310	(23)	1266	(22)	1241	(22)

Engine performance curve for CFP9E-F50 and CFP9EVS-F50

Torque Output

RPM	lb-ft	N-m
1470	1040	1410
1760	1044	1416
1900	1003	1360
2100	838	1136
2300	694	941

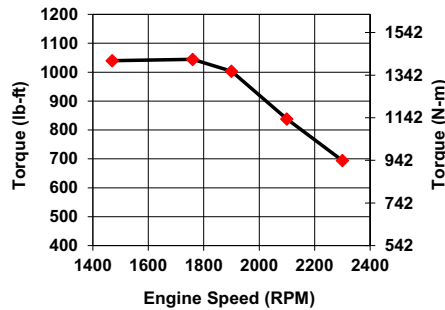

Horsepower Output

RPM	BHP	kW
1470	291	217
1760	350	261
1900	363	271
2100	335	250
2300	304	227

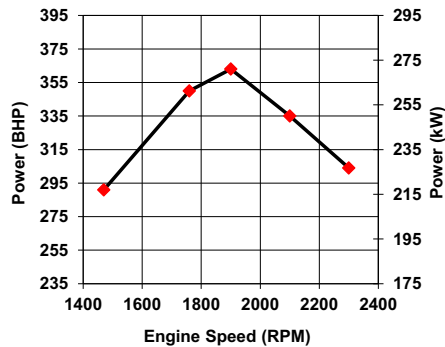

All data is based on the engine operating with a fuel system, water pump, lubricating oil pump, air cleaner, and alternator. The fan, optional equipment, and driven components are not included. Data is based on operation at SAE standard J1349 conditions of 300 ft. (91.4 m) altitude, 29.61 in. (752 mm) Hg dry barometer, and 77 °F (25 °C) intake air temperature, using No.2 diesel fuel only.

Altitude above which output should be limited*: 300 ft. (91.4 m)
 Correction factor per 1000 ft. (305 m) above altitude limit: 3%
 Temperature above which output should be limited: 77 °F (25 °C)
 Correction factor per 10 °F (11 °C) above temperature limit: 1% (2%)
 * Above 3,000 feet, contact Cummins for derate information.

US EPA NSPS Tier 3 Emissions Compliance

Fuel Percentage of Sulfur	D2 Cycle Exhaust Emissions*									
	Grams per BHP - HR					Grams per kW - HR				
	NMHC	NO _x	NMHC + NO _x	CO	PM	NMHC	NO _x	NMHC + NO _x	CO	PM
15 PPM Diesel Fuel	0.123	2.200	2.323	1.417	0.118	0.165	2.950	3.116	1.900	0.158
300-4000 PPM Diesel Fuel	0.149	2.386	2.535	1.417	0.134	0.2	3.200	3.400	1.900	0.180

*The emissions values above are based on CARB approved calculations for converting EPA (500 ppm) fuel to CARB (15 ppm) fuel.

Refer to the engine data tag for the EPA Standard Engine Family.

No special options are needed to meet current regulation emissions for all fifty states. Tests conducted using alternate test methods, instrumentation, fuel, or reference conditions can yield different results.

Diesel Fuel Specifications:

- Cetane Number: 40-48
- Reference: ASTM D975 No. 2-D

Reference Conditions:

- Air Inlet Temperature: 25 °C (77 °F)
- Fuel Inlet Temperature: 40 °C (104 °F)
- Barometric Pressure: 100 kPa (29.53 in Hg)
- Humidity: 107 g H₂O/kg (75 grains H₂O/lb) of dry air; required for NO_x correction
- Intake Restriction set to a maximum allowable limit for clean filter
- Exhaust Back Pressure set to maximum allowable limit

Fire pump digital panel (FPDP)



The Cummins FPDP is an integrated microprocessor-based control system that provides full digital technology with enhanced accuracy and built-in redundancy.

Reliable design - Designed and tested with isolated mounting to minimize vibration for longer life and durability, the Cummins FPDP proves reliable in harsh environments.

Advanced control methodology - The Cummins FPDP allows for Input/Output (I/O) expansion and remote monitoring capabilities, as well as automatic Electronic Control Module (ECM) switching for electronic engines.

Certified quality - The Cummins FPDP is UL 1247 Listed and FM 1333 Approved.

Operator panel features

Operator/display panel

- 7" TFT LCD (thin-film-transistor liquid-crystal display) - color, 24-bit, 800x480 (WVGA).
- Auto, manual, start, stop, and fault reset.
- Assembly enclosure that meets NEMA Type 2 and Type 4X design requirements and is water, corrosion, fire, and impact-resistant.

Electronic engine communications - SAE J1939 protocol.

- Comprehensive full-authority engine (FAE) data: oil pressure and temperature; coolant temperature; and intake manifold pressure and temperature.
- Cummins fault code display.
- Sensor failure indication.
- Optional RS-485 serial - Modbus RTU/Modbus TCP/IP.

Variable speed pressure limiting control (VSPLC) capabilities

- VSPLC status indication.
- Pump discharge pressure display.
- Ability to run the engine at fixed speed from the FPDP at start-up for commissioning.

Other control features

- Digital Panel Expansion Module (DPEM) for additional analog/digital inputs and configurable dry relay contact output.
- Ability to idle at start-up for commissioning of electronic engines.
- Idle cool down for electronic engines.

Functional

- Configurable display units for temperature in degrees Fahrenheit or Celsius and pressure in PSI or kPa.
- Manual ECM selector switch on electronic engines.
- Ability to crank the fire pump drive engine from Battery A, Battery B, or both.
- Fixed engine speed adjustments in +/- 10 RPM increments.
- Overspeed shutdown.

Environmental

- Operating temperature: minus 4 to 140 °F (minus 20 to 60 °C).
- Storage temperature: minus 22 to 176 °F (minus 30 to 80 °C).
- Meets CISPR 11 Class B radiated emissions.

Electrical

- 8-30 VDC operating voltage.
- Reverse polarity protected.
- Spring cage terminal block interface.
- Built-in dual micro controllers for increased reliability.

Mechanical

- 1 3/8" pre-cut customer conduit knockout for easy field installation.
- Simplified internal design for efficiency and ease of customer connections.
- 16GA ASTM A366 material - 316 stainless steel optional.
- RAL3001 red powder coat finish.

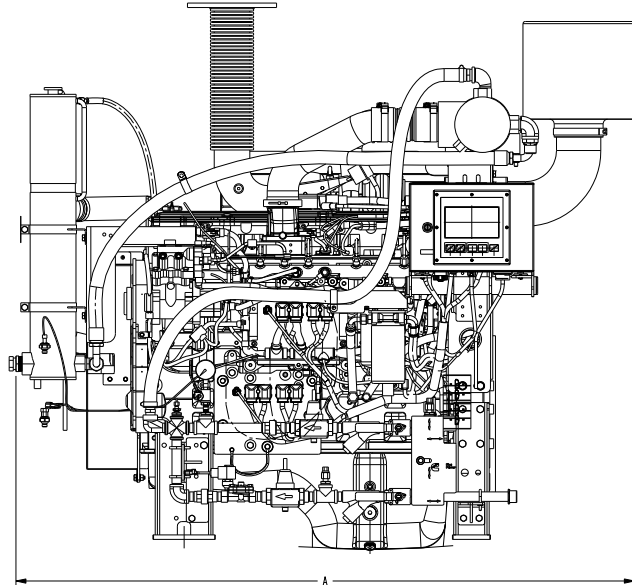
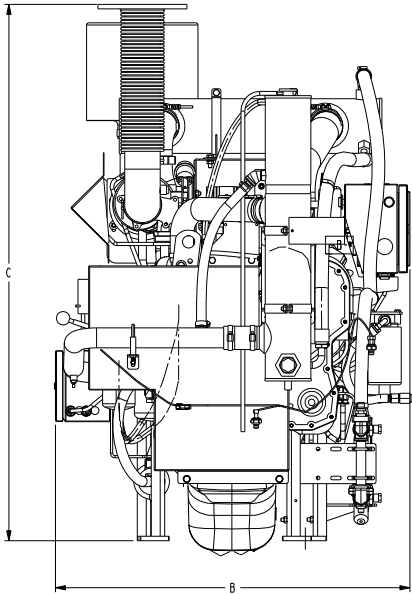

This outline drawing is for reference only.
Do not use for installation design.

	Dim "A" in. (mm)	Dim "B" in. (mm)	Dim "C" in. (mm)
CFP9E F10-F50	69 (1764)	40 (1016)	60 (1524)

NOTE: Consult drawings or contact the factory for additional information.

NOTE: Specifications are subject to change without notice. Codes or standards compliance may not be available with all model configurations - consult factory for availability.
For more information, contact firepumpsales@cummins.com.



This product has been manufactured under the controls established by a Bureau Veritas Certification approved management system that conforms with ISO 9001:2015.



Cummins Inc.
Box 3005
Columbus, IN 47202-3005
U.S.A.

1-800-CUMMINS™ (1-800-286-6467)
cummins.com

Printed in U.S.A.
©2021 Cummins Inc.